

# Product Catalog 01

产品目录 VOI.

为了高品质的消防保护  
For High-quality Fire Protection



**IRON MAN**  
Fire Prevention & Service



上海铁人消防成套设备有限公司是提供消防安全咨询和产品供应的专业型企业。我们拥有专业的消防产品应用设计咨询服务队伍，了解自动灭火系统、消火栓系统、消防车、灭火器、消防水带、软管卷盘、闸阀、蝶阀、止回阀等消防产品的中国GB、美国NFPA、欧盟EN、英国BS、澳大利亚AS、俄罗斯GOST产品标准、工程设计和施工规范，与国内外众多优秀的消防安全产品专业厂家建立了良好互信的合作关系。我们专注于国内外资、合资项目市场和国外外援、外建项目市场，为客户提供消防安全产品、工程设计和施工的整体解决方案。

公司拥有独立进出口权，熟悉国际贸易规则，有着丰富的国际商务运作经验。我们秉承“为了高品质的消防保护”的理念，为国内外客户提供优质的服务。

Shanghai Iron Man Fire Fighting Equipment Co.,Ltd. is a professional enterprise which can do fire safety consultants and products provision. We have a professional fire protection product application design consulting services team who understand the products standards, engineering design and construction codes such as GB, NFPA, EN, BS, AS and GOST for the automatic fire extinguishing systems, fire hydrant system, fire truck, fire extinguisher, fire hose, fire hose reel, gate valve, butterfly valve and check valve, etc. We established good cooperative relations of mutual trust with domestic and international numerous excellent fire safety products professional manufacturer. We focus on foreign investment, joint venture projects in domestic market and foreign aid&construction projects in overseas market, to provide fire safety products, engineering design and construction of the overall solution.

Iron Man has independent import and export license, is familiar with international trade rules, has rich experience in international business operation. We adhering to the "For High-quality Fire Protection" concept, to provide quality services for domestic and overseas customers.

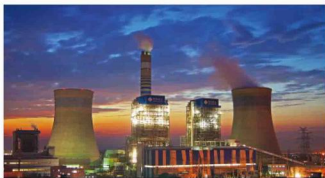

■ 灭火器 Fire Extinguisher	-----	03
■ 消防卷盘 Fire Hose Reel	-----	07
■ 消火栓阀 Landing Valve	-----	12
■ 消防水带及配件 Fire Hose and Accessories	-----	14
■ 消火栓 Fire Hydrant	-----	17
■ 水控制阀 Water Control Valves	-----	20
■ 喷淋系统 Sprinkler System	-----	23
■ 喷淋系统部件 Sprinkler System Parts	-----	25
■ 抗震系统部件 Seismic System Parts	-----	26
■ 沟槽式管件 Grooved Fitting	-----	28
■ 消防装备箱 Fire Equipment Cabinet	-----	29
■ 报警系统 Alarm System	-----	30
■ 缆式感温探测器 Linear Heat Detector	-----	31
■ 消防炮 Fire Monitor	-----	33
■ 其他消防设备 Other Fire Fighting Equipment	-----	34

**手提式ABC干粉灭火器**  
 ABC Dry Powder Extinguishers

Mosafe干粉灭火器用于绝大部分A、B、C类火灾。所有规格的干粉灭火器都有CE标志、BSI风筝标志、MPA EN3认证和MED认证。Mosafe powder fire extinguishers are used on most types of fires including Class A, B and C fires. All of our powder fire extinguishers are CE Marked, BSI Kitemarked, MPA EN3 and MED Approved.



灭火器类型 Extinguisher Type	1Kg Powder	2Kg Powder	4Kg Powder	6Kg Powder	6Kg Powder	9Kg Powder	12Kg Powder
型号 Model No.	PDB10 PDC10	PDB20 PDC20	PDB40	PDB60 PDA60	PRB60 PRA60	PDB90	PDB120
容量 Capacity	1Kg	2Kg	4Kg	6Kg	6Kg	9Kg	12Kg
防火等级 Fire Rating	8A/34B/C 5A/34B/C	13A/89B/C 13A/70B/C	27A/183B/C	43A/233B/C 55A/233B/C	43A/233B/C 55A/233B/C	55A/233B/C	55A/233B/C
筒体结构 Cylinder Structure	Deep-drawn	Deep-drawn	Deep-drawn	Deep-drawn	Rolling-welded	Deep-drawn	Deep-drawn
操作压力 Operating Pressure	14Bar	14Bar	14Bar	14Bar	14Bar	14Bar	14Bar
喷射时间 Discharge Time	8s	10s	17s	17s	17s	22s	28s
使用温度范围 Temperature Range	-30°C to +60°C	-30°C to +60°C	-30°C to +60°C	-30°C to +60°C	-30°C to +60°C	-30°C to +60°C	-30°C to +60°C

**手提式泡沫灭火器**  
 AFFF Foam Extinguishers

Mosafe泡沫灭火器专为有A类和液体可燃材料的B类多风险区域设计。配置能产生高效范围泡沫的喷嘴，即使是无经验的操作者也能正常使用。所有规格的泡沫灭火器都有CE标志、BSI风筝标志、MPA EN3认证和MED认证。Mosafe foam extinguishers are ideal for multi-risk situations where Class A and B fire that typically involve liquids or materials. All models have a spray nozzle which produces a very effective spread of foam, even when used by an inexperienced operator. All of our foam fire extinguishers are CE Marked, BSI Kitemarked, MPA EN3 and MED Approved.

灭火器类型 Extinguisher Type	6L Foam	9L Foam
型号 Model No.	FDAB0/SFRA60 FDC60	FDAB0 FDC90
容量 Capacity	6L	9L
防火等级 Fire Rating	27A/183B 21A/183B	34A/233B 21A/233B
筒体结构 Cylinder Structure	Rolling-welded	Deep-drawn
操作压力 Operating Pressure	12Bar	12Bar
喷射时间 Discharge Time	22s	30s
使用温度范围 Temperature Range	+5°C to +60°C	+5°C to +60°C



### 手提式二氧化碳灭火器 CO<sub>2</sub> Extinguishers



Mosafe CO<sub>2</sub>灭火器专为B类、C类火设计。所有规格的CO<sub>2</sub>灭火器都有CE标志、BSI风筝标志、MPA、EN3认证。  
Mosafe industry leading fire extinguishers offer protection against Class B and C fires. All of our CO<sub>2</sub> extinguishers are CE Marked, BSI Kitemarked and MPA EN3 Approved.



灭火器类型 Extinguisher Type	2Kg CO <sub>2</sub>	5Kg CO <sub>2</sub>
型号 Model No.	CA20S	CA50S
容量 Capacity	2Kg	5Kg
防火等级 Fire Rating	34B	70B
筒体结构 Cylinder Structure	Alloy	Alloy
操作压力 Operating Pressure	170Bar	170Bar
喷射时间 Discharge Time	10s	15s
使用温度范围 Temperature Range	-20 °C to +60 °C	-20 °C to +60 °C

### 手提式清水灭火器 Water Fire Extinguishers



Mosafe清水灭火器专为A类火设计，不能用于带电设备火灾。灭火器充装的是纯水，对环境安全。所有规格的泡沫灭火器都有CE标志、BSI风筝标志、MPA EN3认证和MED认证。  
Mosafe water fire extinguishers offer protection against Class A fires, not for live electrical equipment. The extinguisher is filled only with pure water and is safe for the environment. All of our water fire extinguishers are CE Marked, BSI Kitemarked, MPA EN3 and MED Approved.



灭火器类型 Extinguisher Type	6L Water	9L Water
型号 Model No.	WDA90 WDB60	WDA90
容量 Capacity	6L	9L
防火等级 Fire Rating	13A 34A	21A
筒体结构 Cylinder Structure	Deep-drawn	Deep-drawn
操作压力 Operating Pressure	12Bar	12Bar
喷射时间 Discharge Time	30s	65s
使用温度范围 Temperature Range	+5 °C to +60 °C	+5 °C to +60 °C

**内置储气瓶干粉灭火器**

Internal Cartridge Dry Powder Extinguisher



Mosafe 内置储气瓶干粉灭火器对于高危险区（例如采矿、水电、林业、交通、石油和重工业）需要的快速、有效的防火是理想的。每个灭火器都是用二氧化碳作为动力气体。应用于6公斤、9公斤干粉和6升、9升泡沫。我们的内置储气瓶干粉灭火器是有CE标志的。

Mosafe cartridge fire extinguishers are idea for high-hazard area where fast, effective fire protection is needed such as mining, utilities, forestry, transportation, petroleum and heavy industry. All units use carbon dioxide (CO2) as the expellant gas. Available in 6 kg, 9kg powder and 6L, 9L foam. Our cartridge fire extinguishers are CE Marked.

灭火器类型 Extinguisher Type	6 Kg Powder	9 Kg Powder
型号 Model No.	GPDA60	GPDB90
容量 Capacity	6 Kg	9 Kg
防火等级 Fire Rating	55A/233B/C	55A/233B/C
钢瓶压力 Cylinder Pressure	Deep-drawn	Deep-drawn
操作压力 Operating Pressure	14Bar	14Bar
喷射时间 Discharge Time	17s	22s
温度范围 Temperature Range	-30 °C to +60 °C	-30 °C to +60 °C

**手提式湿式化学灭火器**

Wet Chemical Extinguishers



Mosafe湿式化学灭火器专为F类火灾设计，用于扑灭小的商业厨房的烹饪油火灾，也可以扑灭小的A类火。所有规格的湿式化学灭火器都有CE标志、BSI风筝标志、MPA EN3认证和MED认证。

Mosafe wet chemical fire extinguishers offer protection against Class F fires to fight cooking oil fire s in small commercial kitchens, and also offer a small "A" fire rating. All of our wet chemical fire extinguishers are CE Marked, BSI Kitemarked, MPA EN3 and MED Approved.

灭火器类型 Extinguisher Type	6L Wet Chemical
型号 Model No.	KDA60
容量 Capacity	6L
防火等级 Fire Rating	34A/233B/75F
筒体结构 Cylinder Structure	Deep-drawn
操作压力 Operating Pressure	12Bar
喷射时间 Discharge Time	30s
使用温度范围 Temperature Range	+5 °C to +60 °C



推车式泡沫灭火器  
Wheeled Foam Fire Extinguishers



Mosafe推车式泡沫灭火器专为仓库和大的工业场所设计，推车部件采用了坚固耐磨损的材料，使得移动非常容易和轻便。所有规格的推车式泡沫灭火器都有CE标志和BSI风筝标志。

Mosafe foam wheeled fire extinguishers are the perfect fire protection equipment for use on warehouses and lager industrial sites. The trolley units are manufactured from sturdy and robust material to make the extinguishers easy to move. All of our wheeled foam fire extinguishers are CE Marked and BSI Kitemarked.

灭火器类型 Extinguisher Type	50L Foam
型号 Model No.	TFA60
容量 Capacity	50L
防火等级 Fire Rating	34A-IIIIB-C
筒体结构 Cylinder Structure	Rolling-welded
操作压力 Operating Pressure	12Bar
喷射时间 Discharge Time	60s
使用温度范围 Temperature Range	+5 C to +60 C



推车式干粉灭火器  
Wheeled Powder Fire Extinguishers



Mosafe推车式干粉灭火器专为仓库和大的工业场所设计，推车部件采用了坚固耐磨损的材料，使得移动非常容易和轻便。所有规格的推车式干粉灭火器都有CE标志和BSI风筝标志。

Mosafe powder wheeled fire extinguishers are the perfect fire protection equipment for use on warehouses and lager industrial sites. The trolley units are manufactured from sturdy and robust material to make the extinguishers easy to move. All of our wheeled foam fire extinguishers are CE Marked and BSI Kitemarked.

灭火器类型 Extinguisher Type	50Kg Powder
型号 Model No.	TPB500
容量 Capacity	50Kg
防火等级 Fire Rating	55A-IIIIB-C
筒体结构 Cylinder Structure	Rolling-welded
操作压力 Operating Pressure	14Bar
喷射时间 Discharge Time	50s
使用温度范围 Temperature Range	-30 C to +60 C







CE0832 EN694 EN671

CE标志, LPCB认证, EN671-1标准  
ARE CE-MARKED AND LPCB APPROVED ACCORDING TO EN671-1

**消防软管卷盘**

PKHR01-04, 06-09 FIRE HOSE REEL



- PIKE特定EN694红色软管  
PIKE special red hose comply with EN694.
- 低硬度盘片喷涂红色RAL3000  
Mild steel side discs powder coated RAL3000 red.
- 黑色塑料罩筒用钢螺栓固定  
Black plastic drum reinforced by steel bolt.
- 1" x 1m软管带1"手动球阀  
1"x1m hose with 1" manual ball valve.
- 卷盘进出口配置PIKE快速转换接头  
PIKE quick-change coupling on the reel inlet and outlet.
- 碳钢摇臂  
Carbon steel swing arm bracket.
- 顺时针旋转  
Clockwise rotation.
- 核心部件是黄铜  
Centre parts made of brass.
- 导向装置使软管能从任何方向出来  
Roller hose guide allowing hose to run out in any direction.
- PIKE安装说明书  
PIKE installation instructions.
- PKHR03, 04, 06, 09自动集成自动截止阀, 在卷盘旋转2圈后完全打开  
PKHR03, 04, 06, 09 automatic types have integrated automatic stop valve which will fully open after 2 revolutions of the reel.

**选项**  
OPTIONS

- 黑色软管  
Black hose.
- N-10EN-11喷嘴  
N-10 or N-11 nozzle.
- A, B, D软管导向装置  
A, B or D hose guide.
- 壁挂式安装支架  
Wall mounted bracket.
- 柜体嵌入式安装支架  
Cabinet mounted bracket.
- 不锈钢刷边片  
Stainless steel brush side discs.
- 圆盘中心压力表  
Disc centre pressure gauge.
- PKHR06-09进口球阀和压力表  
PKHR06-09 inlet ball valve with pressure gauge.
- PKHR01-04 3/4" 1m的软管和1" 手动球阀  
PKHR01-04 3/4"x1m hose with 1" manual ball valve.

型号 Model	操作类型 Operation Type		软管长度 Hose Length(m)						盘面直径 Disc Diameter Ø(mm)			盘面间距 Disc Distance(mm)				认证 Approval	
	手动 Manual	自动 Automatic	19mm			25mm			470	550	600	80	120	150	180		
			20	25	30	45	20	25									30
PKHR01	•		•						•	•				•	•	•	LPCB
	•			•					•	•				•	•	•	LPCB
PKHR06	•								•	•				•	•	•	LPCB
	•								•	•				•	•	•	LPCB
PKHR02	•							•	•					•	•	•	LPCB
	•								•	•				•	•	•	LPCB
PKHR07	•								•	•				•	•	•	LPCB
	•								•	•				•	•	•	LPCB
PKHR03		•							•	•			•	•	•	•	LPCB
		•							•	•			•	•	•	•	LPCB
PKHR08		•							•	•			•	•	•	•	LPCB
		•							•	•			•	•	•	•	LPCB
PKHR04		•							•	•			•	•	•	•	LPCB
		•							•	•			•	•	•	•	LPCB
PKHR09		•							•	•			•	•	•	•	LPCB
		•							•	•			•	•	•	•	LPCB



CE标志, LPCB认证, EN671-1标准  
ARE CE-MARKED AND LPCB APPROVED ACCORDING  
TO EN671-1

### 消防软管卷盘 PKHR05 FIRE HOSE REEL



- PKHR05 低碳钢盘片喷涂红色RAL3000  
PKHR05 with mild steel side discs powder coated RAL3000 red.
- 碳钢管摆臂  
Carbon steel pipe swing arm.
- 钢滚筒  
Steel drum.
- PIKE特定EN694红色软管  
PIKE special red hose comply with EN694.
- 核心部件是黄铜  
Centre parts made of brass.
- 顺时针旋转  
Clockwise rotation.
- PIKE安装说明书  
PIKE installation instructions.



CE0832  
EN694  
EN671

型号 Model	操作类型 Operation Type		软管长度 Hose Length(m)			盘筒直径 Disc Diameter Ø(mm)		盘筒间距 Disc Distance(mm)			认证 Approval
	手动 Manual	自动 Automatic	33mm			550	600	200	250	300	
			20	25	30						
PKHR05	•	•	•	•	•	•	•	•	•	•	LPCB

### 消防软管卷盘 PKHR10 FIRE HOSE REEL



- PIKE特定EN694红色软管  
PIKE special red hose comply with EN694.
- 低碳钢盘片喷涂红色RAL3000  
Mild steel side discs powder coated RAL 3000 red.
- 黑色塑料滚筒用钢螺栓固定  
Black plastic drum reinforced by steel bolt.
- 卷盘进出口配置PIKE快速转换接头  
PIKE quick-change coupling on the reel inlet and outlet.
- 铝摇臂支架  
Aluminium swing arm bracket.
- 顺时针旋转  
Clockwise rotation.
- 核心部件是黄铜  
Centre parts made of brass.
- PIKE安装说明书  
PIKE installation instructions.



CE0832  
EN694  
EN671

型号 Model	操作类型 Operation Type		软管长度 Hose Length(m)						盘筒直径 Disc Diameter Ø(mm)			盘筒间距 Disc Distance(mm)				认证 Approval
	手动 Manual	自动 Automatic	19mm			25mm			470	550	600	80	120	150	180	
			20	25	30	45	20	25								
PKHR10	•	•	•	•	•	•	•	•	•	•	•	•	•	•	•	-

选项  
OPTIONS

- 黑色软管  
Black hose.
- N-10或N-11喷嘴  
N-10 or N-11 nozzle.

**消防软管卷盘**  
 PKHR11-14 FIRE HOSE REELS

**CE0832**
**EN694**
**EN671**
**选项**  
**OPTIONS**

- 黑色软管  
Black hose.
- N-10或N-11喷嘴  
N-10 or N-11 nozzle to choose.

**PIKE品牌PKHR11-14消防软管卷盘**  
**PIKE MODEL PKHR11-14 SUPPLIED WITH:**

- PIKE特定EN694红色软管  
PIKE special red hose comply with EN694.
- 低碳钢盘片喷涂颜色RAL3000  
Mild steel side discs powder coated RAL3000 red.
- 黑色塑料罩筒用钢螺栓固定  
Black plastic drum reinforced by steel bolt.
- 固定壁装支架  
Fixed wall mounted bracket.
- 顺时针旋转  
Clockwise rotation.
- 核心部件是黄铜  
Centre parts made of brass.
- PIKE安装说明书  
PIKE installation instructions.
- PKHR11, 12: 进口球阀和压力表  
PKHR11, 12: Inlet ball valve with pressure gauge.
- PKHR13, 14: 入口球阀盖和钥匙  
PKHR13, 14: Inlet lock shield valve with key.

型号 Model	操作类型 Operation Type		软管长度 Hose Length(m)						盘面直径 Disc Diameter Ø(mm)				盘面间距 Disc Distance(mm)				认证 Approval
	手动 Manual	自动 Automatic	19mm			25mm			470	550	600	80	120	150	180		
			20	25	30	36	20	25								30	
PKHR11	●		●						●	●		●	●	●	●	LPCB	
	●			●					●	●			●	●	●		
PKHR13	●				●					●			●	●	●	LPCB	
	●				●	●					●		●	●	●		
PKHR12	●						●			●	●		●	●	●	LPCB	
	●						●			●	●		●	●	●		
PKHR14	●									●				●	●	LPCB	
	●									●			●	●	●		

消防软管卷盘箱  
PKHRC01-01 FIRE HOSE REEL CABINETS

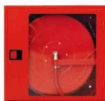

PKHRC01



PKHRC02



PKHRC04



PKHRC03



PKHRC06-1



PKHRC06-2



PKHRC05-1



PKHRC05-2



CE0832

EN694

EN671

材质  
MATERIAL

- 全镀锌钢板喷涂红色RAL3000  
Complete mild steel sheet with powder coated RAL 3000 red.
- 全不锈钢拉丝或镜面  
Complete stainless steel with brush or mirror surface.
- 前门不锈钢和后背镀锌钢板涂红色  
Front door stainless steel finish & back box mild steel red powder coated.

- 墙面式和嵌入式安装  
Wall & recessed mounted type.
- 塑料锁或不锈钢锁  
Plastic lock or stainless steel round lock.
- 铰链在右边  
Hinges on right hand side.
- 预制入孔位于左右两侧  
Prefab inlet holes locate at both left and right sides.
- 墙面式卷盘箱的孔位于箱子底部  
Drain holes for wall mounted type locate at the bottom of box.
- 墙面式卷盘箱的通风百叶窗位于左右两侧  
Vent shutters for wall mounted type locate at both left and right sides.
- 墙面式卷盘箱的固定安装孔位于箱子背面  
Fixed installation holes for wall mounted type locate at the back side of box.
- PIKE安装说明书  
PIKE installation instructions.



喷嘴  
PKHRV - NOZZLE

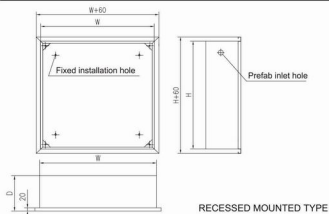
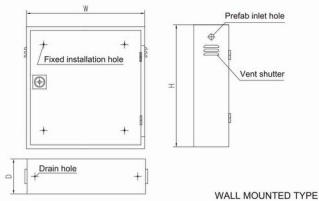

阀门  
PKHRV - VALVE

**消防软管卷盘箱**  
 PKHRC01-01 FIRE HOSE REEL CABINETS

**CE0832**
**EN694**
**EN671**

- 柜边形状是任意的，门打开的角度可以超过160°。  
 The cabinets were free from sharp edges and the doors could be opened to an angle more than 160°.

型号 Model	柜体尺寸 Cabinet Dimension		最大盘面直径和盘面间距 Maximum Disc Diameter and Distance						
	(mm)		盘面直径 Disc Diameter Ø(mm)			盘面直径 Disc Diameter Ø(mm)			
	W	H × D	470	550	600	80	120	150	180
PKHRC01	600 × 600 × 210			•			•		
	600 × 600 × 210		•					•	
	680 × 680 × 230			•				•	
	760 × 720 × 230				•				•
	600 × 600 × 210			•			•		
PKHRC02	600 × 600 × 210		•						
	760 × 720 × 230				•			•	
	760 × 760 × 240				•				•
	840 × 840 × 300				•				•
PKHRC03	1030 × 720 × 230				•			•	
	1050 × 800 × 280				•				•
PKHRC04	680 × 680 × 230		•					•	
	680 × 680 × 230			•			•		
	700 × 700 × 300			•					•
PKHRC05	700 × 700 × 250			•					•
	750 × 750 × 280				•			•	
	780 × 780 × 250			•					•
	780 × 780 × 280				•			•	
	800 × 800 × 280			•					•
PKHRC06	840 × 840 × 300				•			•	
	700 × 1400 × 250			•				•	
	750 × 1500 × 280				•			•	
	780 × 1560 × 250			•					•
	780 × 1560 × 280			•					•
800 × 1600 × 280				•			•		

## 消火栓阀 Landing Valve

上海铁人消防成套设备有限公司  
Shanghai Iron Man Fire Fighting Equipment Co., Ltd.

消火栓阀用于室内消火栓箱，给消防水带，水枪供水，有CE标志，BSI风筝标志。

The landing valves are installed in fire hose cabinet, to supply water for fire hose and branchpipe. The valves are CE marked and Kitemarked.



标准 Standard	通过BSI BS 5041-1批准证书 Certificate to BS 5041-1 Approve by BSI
阀体 Body	铜合金 厚度 ≥ 3毫米 Copper alloy, Thickness ≥ 3mm
手轮 Hand wheel	灰口铸铁或铝合金 Grey cast iron or Aluminum alloy
盖帽 Black cap	铜合金或塑料 Copper alloy or Plastic
进口 Inlet	法兰或BSP螺纹 Flanged or BSP Screwed
出口 Outlet	BS336快速接口-母接口 Female instantaneous to BS336
表面 Surface	红色或黄色喷漆 Red or yellow painting
压力测试 Test pressure	22.5 bar 22.5 bar
流量 Flow rates	超过8.5L/S More than 8.5L/S
全打开 Fully open	4.5圈 4.5turns

### 直角消火栓阀 Right Angle Landing Valve



尺寸 Size	进口 Inlet	出口 Outlet
DN50	165F	BS336
DN65	185F	BS336
DN65	2.5"BSPT	BS336
DN65	2.5"BSP	BS336

### 鼻型消火栓阀 Bib Nose Type Landing Valve



尺寸 Size	进口 Inlet	出口 Outlet
DN50	165F	BS336
DN65	185F	BS336
DN65	2.5"BSPT	BS336
DN65	2.5"BSP	BS336

### 斜式消火栓阀 Oblique Type Landing Valve



尺寸 Size	进口 Inlet	出口 Outlet
DN50	165F	BS336
DN65	185F	BS336
DN65	2.5"BSPT	BS336
DN65	2.5"BSP	BS336
DN65	2.5"BSPIF	BS336

### 水平式消火栓阀 Horizontal Type Landing Valve



尺寸 Size	进口 Inlet	出口 Outlet
DN50	165F	BS336
DN65	185F	BS336
DN65	2.5"BSPT	BS336
DN65	2.5"BSP	BS336

美式室内灭火栓阀通过UL、FM认证，配合水带挂架使用，质量可靠。  
 American Type landing valve were certified by UL and FM, use with hose rack, reliable in quality.

### 直角水带阀门

Angle Hose Valve



阀体: ASTM B283 C37700  
 Body: ASTM B283 C37700  
 手轮: 球墨铸铁  
 Hand wheel: Ductile Iron  
 进口: NPT母螺纹  
 Inlet: NPT  
 出口: NPT公螺纹/NPT母螺纹  
 Outlet: MNST/FNPT  
 表面: 黄铜本色  
 Surface: Polished Brass  
 压力等级: 300PSI  
 Pressure rating: 300PSI  
 尺寸: 2.5" x 1.5"  
 Size: 2.5, 1.5"

### 减压型直角阀门

Pressure Reducing Device Angle Valve



阀体: ASTM B283 C37700  
 Body: ASTM B283 C37700  
 手轮: 球墨铸铁  
 Hand wheel: Ductile Iron  
 进口: NPT母螺纹  
 Inlet: NPT  
 出口: NPT公螺纹/NPT母螺纹  
 Outlet: MNST/FNPT  
 表面: 黄铜本色  
 Surface: Polished Brass  
 压力等级: 175PSI  
 Pressure rating: 175PSI  
 尺寸: 2.5" x 1.5"  
 Size: 2.5, 1.5"

### 减压型灭火栓阀

Pressure Regulating Valve (PRV)



R寸 Size	进口 Inlet	出口 Outlet
DN50	165F	BS336
DN65	185F	BS336
DN65	2.5" BSPT	BS336
DN65	2.5" BSP	BS336

标准 Standard	通过BSI BS 5041-1批准证书 Certificate to BS 5041-1 Approved by BSI
阀体 Body	铜合金, 厚度 ≥ 3毫米 Copper alloy, Thickness ≥ 3mm
手轮 Hand wheel	灰口铸铁或铝合金 Grey cast iron or Aluminum alloy
盖帽 Black cap	铜合金或塑料 Copper alloy or Plastic
出口 Outlet	BS336快速接口-母接扣 Female instantaneous to BS336
表面 Surface	红色或黄色喷漆 Red or yellow painting
压力测试 Test pressure	30 bar
全开 Fully open	4.5 圈 4.5 turns
进口压力 Inlet pressure	20bar, 调节出口静压 5 - 8bar 20bar, regulating outlet static pressure 5 - 8 bar
进口压力 Inlet pressure	20bar, 调节出口静压 > 20bar 20bar, regulating outlet static pressure > 20 bar

### 集水器

Breaching Inlets



标准 Standard	通过BSI BS 5041-3批准证书 Certificate to BS 5041-3 Approved by BSI
身体 Body	球墨铸铁 Ductile Cast Iron
接头 Hand wheel	1" 球阀 BS 5154 1" gate valve BS 5154
非返回测试 Pressure rating	1.7 bar 1.7 bar
进口 Inlet	铜合金到公螺纹瞬间与NRV连接器BS 336 Copper alloy to male instantaneous coupling with NRV to BS 336
出口 Outlet	2路4寸法兰, 4路6寸法兰 4" flange for 2-way, 6" flange for 4-way
盖帽 Blank cap	塑料或橡胶 Plastics or Rubber
表面 Surface	红色或黄色喷漆 Red or yellow painting
压力测试 Size	30 bar
工作压力 Size	20 bar

我们能按NFPA、EN、BS等标准生产不同编织层和衬里的消防水带，配上不同标准的接口。  
We can manufacture the fire hose with different jacket and liner according to NFPA, EN and BS standard, and assembled with different standard coupling.

EPDM衬里消防水带  
EPDM Fire Hose



产品特点：重量轻，结构紧密，耐腐蚀，耐老化，耐气候，耐臭氧，耐水解，抗霉变，抗紫外线，使用寿命长。  
Features: Light weight; Construction tightness; Corrosion resistance; Aging resistance; Weather resistance; Ozone resistance; Hydrolysis resistance; Mildew resistance; UV resistance and long serving life.

应用范围：消防；船舶；石油；化工；农业；矿山等  
Application: Fire-fighting; Shipping; Petroleum; Chemical industry; Agriculture; Mining, etc.

生产标准：GB6246, MED, EN14540, FM, UL  
Standard: GB6246, MED, EN14540, FM, UL

口径：1" - 6"  
Size: 1" - 6"

TPU衬里消防水带  
TPU Fire Hose



产品特点：重量轻，耐臭氧，耐磨损，耐低温，耐油，耐弯曲；摩擦损失少，使用寿命长。  
Features: Light weight; Ozone resistance; Abrasion resistance; Low-temperature resistance; Oil resistance; Flexure resistance; Low friction loss less for maximum flow; Long serving life.

应用范围：消防；船舶；石油；化工；农业；矿山等。  
Application: Fire-fighting; Shipping; Petroleum; Chemical industry; Agriculture; Mining, etc.

生产标准：GB6246, EN14540, UN19487, 或者根据客户要求标准。  
Standard: GB6246, EN14540, UN19487, or as per customer's instruction.

口径：1" - 6"  
Size: 1" - 6"

PVC衬里消防水带  
PVC Fire Hose



产品特点：重量轻，弹性好，水流阻力小，易卷绕。  
Features: Light weight; Good elasticity; Small flow resistance; Easy to wind and roll.

应用范围：消防；船舶；石油；化工；农业；矿山等。  
Application: Fire-fighting; Shipping; Petroleum; Chemical industry; Agriculture; Mining, etc.

生产标准：GB6246, EN14540, UN19487, 或者根据客户要求标准。  
Standard: GB6246, EN14540, UN19487, or as per customer's instruction.

口径：1" - 6"  
Size: 1" - 6"

NBR双面胶水带  
NBR Double Coating Hose



产品特点：强度高，耐油，耐酸，粘接力强，耐水，水流阻力小。  
Features: High-strength; Oil resistance; Resist to acid and alkali; Corrosion resistance; Strong bonding; Cold resistance; Small flow resistance.

应用范围：消防；船舶；石油；化工；农业；矿山等。  
Application: Fire-fighting; Shipping; Petroleum; Chemical industry; Agriculture; Mining, etc.

生产标准：GB6246, EN14540, UN19487, 或者根据客户要求标准。  
Standard: GB6246, EN14540, UN19487, or as per customer's instruction.

口径：1-1/4" - 6"  
Size: 1-1/4" - 6"



我们能根据不同市场的要求，提供各种标准、材质的接扣和水枪，配合水带使用。  
 We can according to the requirements of different markets, offer the hose coupling and branchpipe with a variety of standard and different material, assemble with the fire hose.

**无后坐力可调节水枪**  
 Selectable Gallonage Nozzle

可选择喷射或是喷雾  
 Can be jet and fog operate  
 重量: 1.9kg; 材质: 铝  
 Weight: 1.9kg; Material: aluminum.  
 流量范围: 115L, 230L, 360L, 475L @ 6Bar  
 Flow range: 115L, 230L, 360L, 475L @ 6bar.  
 进口尺寸: 1.5" (40mm)  
 Inlet size: 1.5" (40mm)  
 接头: Storz/NH/BSP等等  
 Coupling: Storz/NH/BSP, etc.

**直流/喷雾喷嘴**  
 Jet/Spray Nozzles

尺寸 Size	入口 Inlet	出口 Outlet
DN65	BS336	20mm
DN65	BS336	25mm

**直流/喷雾水枪**  
 Jet/Spray Branchpipe

尺寸 Size	入口 Inlet	出口 Outlet
DN40	1.5BSP	15mm
DN40	1.5NST	15mm
DN65	2.5BSP	20mm
DN65	2.5NST	20mm

**直流/喷雾水枪**  
 Jet/Spray Branchpipe

尺寸 Size	入口 Inlet	出口 Outlet
DN50	G 2"	16mm
DN50	Storz-C	16mm
DN65	BS336	20mm

**消防水带喷嘴/支管**  
 Fire Hose Nozzle / Branch Pipe

消防水带喷嘴是BS标准 (喷射/喷雾支管)  
 Fire hose nozzle, also in BS standard (jet/spray branchpipe)  
 拥有BS认证书和TUV认证  
 BS有BSI证书和TUV认证  
 BS type, we have the BSI certificate and TUV approval.  
 三种材质: 塑料和铝, 铝喷射/喷雾边  
 Three materials can be chosen: Plastic with aluminum, aluminum, and aluminum jet/spray with curtain.  
 球阀控制, 尺寸: DN50和DN65  
 Ball valve control Size: DN50 and DN65  
 接头: BS336或可依照所需提供  
 Couplings: BS336 or upon to the customer's request.

**泡沫枪**  
 Foam Branchpipe

尺寸 Size	入口 Inlet	出口 Outlet
DN50	G 2"	2008/400 L/min
DN50	Storz-C	2008/400 L/min
DN65	BS336	2008/400 L/min

**英式直流水枪**  
 BS Branchpipe

尺寸 Size	接口类型 Head	管尾 Tail
DN40	1.5BSP	12.5mm
DN65	BS336	12.5mm
DN65	BS336	15mm
DN65	BS336	20mm

**西班牙式水带接扣 (铝质)**  
 Barcelona Hose Coupling

尺寸 Size	接口 D(mm)	接口类型 Head	管尾 Tail
DN45	62	UNE 45	45mm
DN70	88	UNE 70	70mm

英式接口 (BS336) 黄铜/青铜/铝质  
John Morris Hose Coupling / Brass



尺寸 Size	接口 D(mm)	接口类型 Head	管尾 Tail
1-1/2"	26.6	BS336	38mm
1-3/4"	32.9	BS336	45mm
2"	38.5	BS336	51mm
2-1/2"	51.2	BS336	63.5mm
2-3/4"	56.8	BS336	75mm

俄式水带接口  
Gost Hose Coupling



尺寸 Size	接口 D(mm)	接口类型 Head	管尾 Tail
DN50	78	Gost 50	50mm
DN65	95	Gost 65	65mm
DN80	107	Gost 80	77mm

德式水带公接口 (铝质)  
Storz Hose Coupling with Male Thread



尺寸 Size	入口 Inlet	出口 Outlet
DN25	Storz-D	25mm
DN45	1-3/4" Storz	45mm
DN52	Storz-C	51mm
DN65	2-1/2" Storz	65mm
DN75	Storz-B	75mm
DN110	Storz-A	100mm

澳大利亚水带接口  
Australia Hose Coupling



尺寸 Size	螺纹 Thread	管尾 Tail
DN40	1.5 BSP	38mm
DN65	NSW	38mm
DN65	NSW	65mm
DN65	QRT	38mm
DN65	QRT	65mm

美式水带接口  
NH Hose Coupling



尺寸 Size	接口类型 Head	管尾 Tail
1.5	1.5NH	1-11/16"
1.5	1.5NH	1-13/16"
2.5	2.5NH	2-3/4"
2.5	2.5NH	2-7/8"

美式水带接口 (黄铜)  
NH Hose Coupling



尺寸 Size	接口 D(mm)	接口类型 Head	管尾 Tail
40A	28	1.5 NH	38mm
50A	40	2" NPSH	50mm
65A	54	2.5 NH	65mm

日式快速接口  
Machino Hose Coupling



尺寸 Size	日式接口 Machino	管尾 Tail
40A	1.5	38mm
50A	2"	50mm
65A	2.5	65mm

扣式水带接口  
Camlock Hose Coupling



尺寸 Size	接口类型 Head	管尾 Tail
DN40	1.5"	38mm
DN50	2"	50mm
DN65	2-1/2"	65mm

我们精湛的铸造和喷涂工艺，保证消火栓产品的承压能力强。不泄漏，耐腐蚀。  
 Our exquisite casting and painting process, to ensure the fire hydrant products bearing capacity is strong, no leakage and corrosion resistance.

### 英式两路湿式消火栓配阀门

BS 2 ways fire hydrant with valves



进口 Inlet	出口 Outlet	试验压力 Test pressure
DN100法兰 With flange	2.5 NST×2	435 psi 30bar
	BS336×2	
	2.5 Storz×2	
重量 Weight	材质 Material	
60kg	阀体Body: 铸铁Cast Iron BS 1452	
	阀Valves: 黄铜或青铜 Brass or Bronze	

### 英式两路湿式消火栓配阀门

BS 2 ways fire hydrant with valves



进口 Inlet	出口 Outlet	试验压力 Test pressure
DN100法兰 With flange	2.5 NST×2	435 psi 30bar
	BS336×2	
	2.5 Storz×2	
重量 Weight	材质 Material	
50kg	阀体Body: 铸铁Cast Iron BS 1452	
	阀Valves: 黄铜或青铜 Brass or Bronze	

### 英式两路湿式消火栓

BS 2 ways fire hydrant



进口 Inlet	出口 Outlet	试验压力 Test pressure
DN100法兰 With flange	NSW×2	435 psi 30bar
	2.5 Storz×2	
	BS336×2	
重量 Weight	材质 Material	
65kg	阀体Body: 铸铁Cast Iron BS 1452	
	阀Valves: 黄铜或青铜 Brass or Bronze	

### 英式三路4" 干式消火栓

BS 3 ways 4" fire hydrant



进口 Inlet	出口 Outlet	
DN100法兰, 中体800mm With flange 800mm DN100 With flange 1200mm	2.5 NH×2	4 NH
	2.5 Storz×2	4 Storz
	BS336×2	4 BSRT
重量 Weight	材质 Material	
130kg 150kg	阀体Body: 铸铁Cast Iron BS 1452	
	阀Valves: 黄铜或青铜 Brass or Bronze	

英式三路6" 干式消火栓配阀门  
BS 3 ways 6" fire hydrant with valve

	进口 Inlet	出口 Outlet	
	DN150法兰, 中径800mm With flange 800mm DN150 With flange 1200mm	2.5 NHx2	4 NH
		2.5 Storzx2	4 Storz
	重量 Weight	BS336x2	4 BSRT
180kg	材料 Material		
205kg	阀体Body: 铸铁Cast iron BS 1452		
	阀Valves: 黄铜或青铜 Brass or Bronze		

俄式干式消防栓  
Russian Fire Hydrant Dry Barrel



韩式两路4" 干式消火栓  
2 Ways 4" Fire Hydrant



英式地下消火栓  
BS Under Ground Hydrant



尺寸 Size	H高 (mm)	W宽 (mm)	进口 Inlet	出口 Outlet
DN80	270	286	35	BSRT
Flange	270	286	35	DN80
DN100	270	286	35	BSRT
Flange	270	286	35	DN80

消防立管  
Fire Standpipe

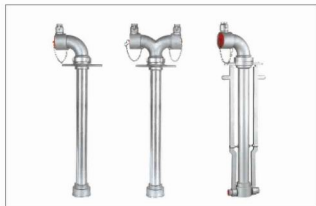

**美式湿式消防栓**

American Type Fire Hydrant Wet-Barrel



弹性阀座，球墨铸铁阀体。  
 Resilient seated, DI Body  
 工作压力：UL, 200PSI / FM 250PSI  
 Working pressure: UL, 200PSI / FM 250PSI

**美式干式消防栓**

American Type Dry Barrel Fire Hydrant



标准 Standard	符合AWWA C502 Comply with AWWA C502
工作压力 Working pressure	250 psi 250PSI
工作温度 Working temperature	0-80度 0-80 Degree
认证 Construction	FM认证 & UL认证 FM approved & UL listed
进口 Inlet	法兰连接(PN16或ANSI)环氧树脂面涂红色；一个水泵接口 4" 4 1/2"；两个软管喷嘴2 1/2" Flanged or BSP Screwed, Epoxy coated on red, One pimper nozzle 4 7/4 1/2" with two hose nozzles 2 1/2"



部件 Part	规格说明 Specification	部件 Part	规格说明 Specification	部件 Part	规格说明 Specification
栓体 Hydrant Body	ASTM A536	破碎法兰 Breakable Flange	ASTM A126B	衬套 Hydrant Bonnet	ASTM A536
密封圈 Seal-ring	ASTM B584	螺栓 Bolts	ASTM A574	油杯 Oil Cup	
O型圈 O-ring	EPDM	接头 Coupling	ASTM A536	O型圈 O-Ring	EPDM
螺塞 Screwed Plug	ASTM B594	销轴 Pin Axes	SS304	衬套 Bush	ASTM B16-H02
主阀法兰 Main Valve Flange	ASTM A536	销 Pin	SS304	防尘圈 Dustproof Ring	EPDM
O型圈 O-ring	EPDM	排水管 Drainage	ASTM A536	两杆螺母 Stem Nut	ASTM B584
阀座 Valve Seat	ASTM B584	上阀杆 Up Stem	ASTM A574M	销轴 Pin Axes	SS304
两瓣垫片 Barrel Gasket	EPDM	链 Link		小锥出口 Small Outlet	ASTM B584
销轴 Pin Axes	SS304	大喷嘴盖 Big Nozzle Cap	ASTM A536	小密封垫片 Small Sealed Gasket	EPDM
底下法兰 lower flange	ASTM A536	大密封垫片 Big Sealed Gasket	EPDM	小喷嘴盖 Small Nozzle Cap	ASTM A53674
密封圈 Seal Ring	SS304	大锥出口 Big Outlet	ASTM B584		
六角螺母 Hex Nuts	ASTM A574	O型圈 O-Ring	EPDM		
双头螺栓 Stud Bolts	ASTM A54	两杆 Stem	SS410		
楔子 Wedge	ASTM A536 with EPDM	六角螺母 Hex Nuts	ASTM A574		
下阀杆 Lower Stem	ASTM A574M	螺钉 Screw	ASTM A574		
两瓣 Barrel	ASTM A536	防松螺母 Stop Nut	454		

### 沟槽连接蝶阀

#### Grooved-End Butterfly Valve

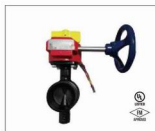

顶部延伸  
Extended neck  
低扭矩操作  
Low torque operation  
双触点监控开关  
Options of double internal supervisory switches  
FM认证和UL认证  
FM Approved & UL Pending  
材质: 球墨铸铁  
Material: ductile iron  
尺寸: 2.5" - 10"  
Size: 2.5" up to 10"

部件 Part	规格说明 Specification
上阀杆 Upper Stem	不锈钢ASTM A 276 类型420 Stainless Steel ASTM A 276 Type 420
上轴承 Upper Bearing	PTFE青铜衬套 PTFE Bronze Sintered on Steel
O型圈 O-ring	EPDM EPDM
阀体 Body	球墨铸铁ASTM A 536, 涂层尼龙 Ductile Iron ASTM A 536, Polyimide Coated
阀瓣 Disc	球墨铸铁ASTM A 536, EPDM包装 Ductile Iron ASTM A 536 with EPDM Encapsulation
下轴承 Lower Bearing	PTFE青铜衬套 PTFE Bronze Sintered on Steel
下阀杆 Lower Stem	不锈钢ASTMA276类型420 Stainless Steel ASTM A 276 Type 420
防尘塞 Dust Plug	PVC PVC
铭牌 Name Plate	不锈钢 Stainless Steel
齿轮执行机构 Gear Operator	铸铁和钢 Cast Iron and Steel
指示标志 Indicator Flag	铸铁 Cast Iron
手轮 Handwheel	铸铁 Cast Iron

### 对夹式蝶阀

#### Wafer Type Butterfly Valve



设计标准: BS EN 593;  
Designs standard: BS EN 593.  
通过按键、平行或斜方形或扁头带驱动杆。  
Stem driven by keys, parallel or diagonal square or flat head.  
工作压力: PN10/16。  
Working pressure: PN10/16.  
温度范围: 0°C - 80°C。  
Temperature range: 0°C - 80°C。  
涂层: 符合ANS/AWWA C550的环氧树脂  
涂层。  
Coating: Fusion bonded epoxy coating in accordance with ANS/AWWA C550.

### Y型过滤器

#### Y-strainer



175PSI, 尺寸: 2-1/2" - 12"  
175PSI Size 2-1/2" - 12"  
铸铁阀体, 不锈钢过滤器  
Q Body: SS Screen  
认证: UL  
Approved UL

### 沟槽连接旋启式止回阀

#### Grooved-End Swing Check valve



水平或垂直安装。  
Installed in both Horizontal or Vertical line with Upward Flow.  
便捷式快速安装和维修。  
Easier and faster to install and maintain.  
低流阻。  
Low pressure drop.  
所有不锈钢部件带环氧涂层, 提供优异的抗腐蚀性。  
All stainless steel wetted parts with epoxy coated body to provide superior corrosion resistance.  
认证: FM&UL  
Certification: FM&UL.

部件 Part	规格说明 Specification
阀体 Body	球墨铸铁ASTM A 536 Ductile Iron ASTM A 536
阀座 Seat	青铜 Bronze
阀瓣 Clapper	不锈钢304 Stainless Steel 304
面密封 Facing Seal	EPDM橡胶 EPDM Rubber
压圈 Clamping Ring	不锈钢304 Stainless Steel 304
垫圈 Gasket	EPDM橡胶 EPDM Rubber
弹簧 Spring	不锈钢304 Stainless Steel 304
铰链销 Hinge Pin	不锈钢304 Stainless Steel 304
螺栓 Bolt	不锈钢304 Stainless Steel 304
防松螺母 Locknut	不锈钢304 Stainless Steel 304
塞子 1/4" NPT Plug 1/4" NPT	碳钢 Carbon Steel
塞子 1/2" NPT Plug 1/2" NPT	碳钢 Carbon Steel

### 法兰止回阀

#### Flange Type Check Valve



低流阻  
Low pressure drop  
EPDM非泄漏密封  
EPDM non-leak tight sealing  
FM认证和UL认证  
FM Approved & UL Listed  
材质: 球墨铸铁  
Material: ductile iron  
尺寸: 2 - 12"  
Size: 2" up to 12"

### 减压阀

#### Pressure Reducing Valve



最大输入压力: 1.0MPa, 1.6MPa, 2.5MPa  
Max inlet pressure: 1.0mpa, 1.6mpa, 2.5mpa  
最小输入压力: P2max+0.2  
Min. inlet pressure: P2max+0.2  
最大输出压力: 0.6MPa, 1.0MPa, 1.6MPa  
Max outlet pressure: 0.6mpa, 1.0mpa, 1.6mpa  
材质: 球墨铸铁  
Material: ductile iron  
最小输出压力: 0.05MPa  
Min. outlet pressure: 0.05mpa

**闸阀**  
Gate Valve



1. 三角O型圈和防尘密封件 Triple O-rings and dirt seal
2. 锻造铜杆和止推环 Forged bronze stem and thrust collar
3. O型圈 O-ring
4. 铜阀杆螺母 Bronze stem nut
5. 聚合楔形轴承帽 Polymer wedge guide bearing caps
6. 超大全端口打开光滑水道 Oversized, full port opening, smooth waterway
7. 环氧树脂涂层系统 Epoxy coating system
8. 底部支撑点 Integral legs
9. 适合的连接标准 Available end connections
10. 可协调提升凸耳 Integrated lift lugs
11. T形螺栓 T-head bolt retention
12. 可调动的密封楔 Self-activating wedge seal

**OS&F弹性座密封闸阀**  
OS&F Resilient Seated Gate Valve



连接方式: 法兰/沟槽/法兰x沟槽  
Flange/Groove/ Flange x Groove Ends  
压力: 200PSI/250PSI/300PSI  
200PSI/250PSI/300PSI  
尺寸: 2.5" -12"  
Size 2.5" -12"  
球墨铸铁的阀体, EPDM密封楔  
DI Body, EPDM Encapsulated Wedge

**OS&Y弹性座密封闸阀**  
OS& Y Resilient Seated Gate Valve



连接方式: 法兰/MJ/法兰x MJ  
Flange/MJ/ Flange x MJ Ends  
250PSI的 尺寸: 14" -18"  
200PSI的 尺寸: 14"-18"  
200PSI的 尺寸: 20" -24"  
200PSI Size 20"-24"  
球墨铸铁的阀体, EPDM密封楔  
DI Body, EPDM Encapsulated Wedge  
FM认证的 尺寸: 14" -16"  
FM Approved for Size 14"-16"

**NRS弹性座密封闸阀**  
NRS Resilient Seated Gate Valve

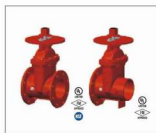

连接方式: 法兰/法兰x沟槽  
Flange/Flange x Groove Ends  
压力: 200PSI/250PSI/300PSI  
200PSI/250PSI/300PSI  
尺寸: 2.5" -12"  
Size 2.5" -12"  
球墨铸铁的阀体, EPDM密封楔  
DI Body, EPDM Encapsulated Wedge

**NRS弹性座密封闸阀**  
NRS Resilient Seated Gate Valve



连接方式: 法兰/MJ  
Flange /MJ Ends  
250PSI的 尺寸: 14" -18"  
200PSI的 尺寸: 14"-18"  
200PSI的 尺寸: 20" -24"  
200PSI Size 20"-24"  
球墨铸铁的阀体, EPDM密封楔  
DI Body, EPDM Encapsulated Wedge  
FM认证的 尺寸: 14" -16"  
FM Approved for Size 14"-16"

**NRS弹性座密封闸阀**  
NRS Resilient Seated Gate Valve



连接方式: 法兰x MJ/MJ  
Flange x MJ/MJ Ends  
压力: 200PSI/250PSI/300PSI  
200PSI/250PSI/300PSI  
尺寸: 3" -12"  
Size 3"-12"  
球墨铸铁的阀体, EPDM密封楔  
DI Body, EPDM Encapsulated Wedge





### 暗杆闸阀指示桩

#### Indicator Post for NRS Gate Valve



内外涂层是FBE  
Fire Coated Interior and Exterior  
最大操作温度 85°C  
Maximum Operating Temperature 85 Degree  
FM和UL认证  
FM&UL certificate  
材质: 球墨铸铁  
Material: ductile iron  
尺寸: 2.5" - 12" / 14" - 24"  
Size 2.5" up to 12" / 14" up to 24"

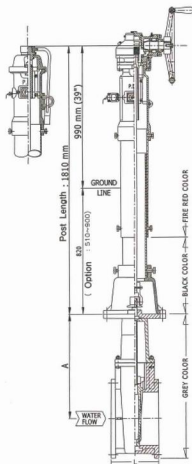

部件 Part	规格说明 Specification	部件 Part	规格说明 Specification
六角形螺栓 Hexagon Bolt	ASTM A105	加载架 Loading Bogie	ASTM A126B
垫圈 Washer	ASTM A105	阀盖 Bonnet	ASTM A536
六角形螺母 Hexagon Nut	ASTM A105	薄片挡圈 Circlip	65Mn
阀座 Seat	ASTM A536	导螺杆 Head Screw	ASTM A105
扳手套筒 Wrench Socket	ASTM A536	六角形螺栓 Hexagon Bolt	ASTM A105
开口销 Cotter Pin	ASTM A105	大垫圈 Big Washer	ASTM A105
六角形螺栓 Hexagon Bolt	ASTM A105	操作螺母 Operating Nut	ASTM C61400
六角形螺母 Hexagon Nut	ASTM A105	T型螺栓 T Bolt	ASTM A105
操作杆 Operating Bar	ASTM A105	方螺母 Square Nut	ASTM A105
阀盖 Bonnet	ASTM A536	垫圈 Cover Board	PMPA
特定U型螺栓 Special U-Bolt	ASTM A536	垫圈 Gasket	硅橡胶 Silicon Rubber
特定U型螺栓 Special U-Bolt	ASTM A105	塞子 Plug	KT30-16
沟槽盘 Slotted Pan	ASTM A105	头螺钉 Head Screw	ASTM A276
六角螺母 Hexagon Nut	ASTM A105	垫圈 Washer	ASTM A105
盖板 Shut Plate	ZL 101	立管 Stand Pipe	ASTM A536
开板 Open Plate	ZL 101		

**标准响应直立型喷头**  
 Standard Response,Upright Sprinkler

**标准响应下垂型喷头**  
 Standard Response,Pendant Sprinkler

**标准响应水平边墙型喷头**  
 Standard Response,Sidewall Sprinkler

**快速响应直立型喷头**  
 Quick Response,Upright Sprinkler

**快速响应下垂型喷头**  
 Quick Response,Pendant Sprinkler

**快速响应水平边墙型喷头**  
 Quick Response,Sidewall Sprinkler

**中速水雾喷头**  
 Medium Velocity Water Spray Nozzle

最大的工作压力: 12 Bar (175 PSI) MAXIMUM WORKING PRESSURE: 12 Bar (175 PSI)
额定工作压力: 1.4 to 3.5 Kg/Sq.cm (20 - 50 PSI) EFFECTIVE WORKING PRESSURE: 1.4 to 3.5 Kg/Sq.cm (20 - 50 PSI)
连接螺纹: 1/2" BSPT (可选择1/2" NPT) Connection thread: 1/2" BSPT (1/2" NPT OPTIONAL)
每个K系数对应的喷射角度: 140°, 120°, 110°, 100°, 90°, 80° & 65° INCLUDED WATER SPRAY ANGLE FOR EACH K-FACTOR: 140°, 120°, 110°, 100°, 90°, 80° & 65°
K系数: (美国公制) K-18,22,30,35,41,51,64,79,91,102 K FACTOR: Metric (US) K-18,22,30,35,41,51,64,79,91,102

## 高速水雾喷头 High Velocity Water Spray Nozzle



最大的工作压力: 175 PSI MAXIMUM WORKING PRESSURE: 12 Bar (175 PSI)
额定工作压力: 3.5 到 10.5 Kg/Sq.cm (50 - 150 PSI) EFFECTIVE WORKING PRESSURE: 3.5 to 10.5 Kg/Sq.cm (50 - 150 PSI)
连接螺纹: 3/4" BSPT (可选择3/4" NPT) Connection thread: 3/4" BSPT (3/4" NPT OPTIONAL)
每个K系数对应的喷射角度: 75°, 80°, 90°, 100°, 115°, 120° INCLUDED WATER SPRAY ANGLE FOR EACH K-FACTOR: 75°, 80°, 90°, 100°, 115°, 120°
K系数: (美国公制) K-18, 22, 32, 26, 42, 23 K-FACTOR METRIC (US) K-18, 22, 32, 26, 42, 23

## 泡沫-水喷头 Foam-Water Sprinkler



最大的工作压力: 12 Bar (175 PSI) MAXIMUM WORKING PRESSURE: 12 Bar (175 PSI)
操作压力: 2.1 Bar (30 PSI) 最小; 4.2 Bar (60 PSI) 最大。 OPERATING PRESSURE: 2.1 Bar (30 PSI) minimum; 4.2 Bar (60 PSI) maximum.
连接螺纹: 1/2" BSPT (可选择1/2" NPT) Connection thread: 1/2" BSPT (1/2" NPT OPTIONAL)
K系数: K-42标准; 可以提供其他K系数作为选择, 无UL认证。 K-FACTOR: K-42 standard; Other K-factor can be provided as optional without UL Listing.

## 隐蔽式喷头 Concealed Sprinkler



响应 & 玻璃球直径: 标准响应, $\phi$ 5mm & 快速响应, $\phi$ 3mm Response & Bulb Nominal Dia: Standard Response, $\phi$ 5mm & Quick Response, $\phi$ 3mm
最大工作压力: 175 psig / 1.2MPa (12 bar) Max. Working Pressure: 175 psig / 1.2MPa (12 bar)
工厂水压试验: 100% @ 500psig (3.4 MPa) Factory Hydrostatic Test: 100% @ 500psig (3.4 MPa)
最小操作压力: 7 psig / 0.048 MPa (0.48 bar) Min. Operating Pressure: 7 psig / 0.048 MPa (0.48 bar)
连接螺纹: NPT 1/2 或者 R1/2 Connection thread: NPT 1/2 or R1/2
公称K系数: 5.6 (美制) / 80 (公称) Nominal K-Factor: 5.6 (U.S.) / 80 (metric)

## 报警阀 Wet Alarm Valve



型号规格: ZSFZ 100/150/200  
Type Standards ZSFZ 100/150/200  
额定压力: 1.6Mpa  
Rated Working Pressure: Mpa: 1.6Mpa  
材质: 球墨铸铁  
Materials: Nodular Cast Iron  
接口形式: 法兰  
Connection thread: Flange  
证书: FM认证  
Certificate FM Approved

## 雨淋阀 Deluge Valve



型号规格: ZSFG 100/150  
Type Standards ZSFG 100/150  
额定压力: 1.6Mpa  
Rated Working Pressure: Max: 1.6Mpa  
材质: 球墨铸铁/不锈钢  
Materials: Nodular Cast Iron/ Stainless Steel  
接口形式: 法兰  
Connection thread: Flange  
证书: FM认证  
Certificate FM Approved

**喷头保护罩**  
 Sprinkler Escutcheons

保护罩面板形式：单面板或者双面板  
 Escutcheon Plate Form: single plate or double plate  
 尺寸：NPT 1/2" 或者 NPT 3/4"  
 Size: NPT 1/2" or NPT 3/4"  
 表面处理：镀铬或白色喷漆  
 Finish: Chrome or White painting  
 材料：碳钢  
 Material: Carbon Steel

**喷头备件箱**  
 Sprinkler Spare Head Cabinet

材料：钢  
 Material: Steel  
 认证  
 RAL3000  
 6瓶，12瓶，24瓶可用  
 6m, 12m, 24m are available  
 可要求喷头类型和柜体尺寸  
 Sprinkler type and cabinet size can upon request

**测试和排水阀**  
 Test and Drain Valve

测试压力：24bar  
 Test pressure: 24bar

工作压力：14bar  
 Working pressure: 14bar

材料：青铜壳体，黄铜阀杆，浸渍聚四氟乙烷底座，镀铬铜球，并在测试和排油位置有一个锁紧停止的钢手柄。  
 Materials: Bronze body, brass stem, impregnated Teflon seat, chrome coated brass ball, and a steel handle with positive stops at the TEST and DRAIN position  
 组件：防篡改的测试孔，整体防篡改视孔眼镜，用于系统接入的一个挖孔并插入的端口，以及钢标识牌。  
 Components: A tamper resistant test orifice, integral tamper resistant sight glasses, a tapped and plugged port for system access, and a steel identification plate.

测试孔口尺寸：公称按照NFPA13要求。  
 Test Orifice Size: Nominal as required by NFPA 13

尺寸：1"，2" 同连接管道；入口和出口：NPT或BS螺纹  
 Size: 1", 2" Same as connected piping. Inlet and Outlet. Threaded NPT or BS

**水流指示器**  
 Waterflow Detector

水流灵敏度范围：4-110GPM (15-38LPM)  
 Flow Sensitivity Range: 4-110GPM (15-38LPM)

触点额定值：8A @ 250VAC, 3A @ 24VAC, 2.5A @ 30VAC  
 Contact rating: 8A @ 250VAC, 3A @ 24VAC, 2.5A @ 30VAC

工作压力：450PSI  
 Working Pressure: 450PSI

工作温度：0°C-68°C  
 Working Temperature: 0°C-68°C

防腐措施：内部和外部喷涂环氧树脂，或者内部和外部喷漆  
 Corrosion Protection: Fusion Bonded Epoxy Coated Interior And Exterior or Enamel Spray Paint, Interior and Exterior

认证：UL, FM, GOST  
 Certificate: UL, FM, GOST

适用管道：水钢管 schedule 10-40  
 Compatible Pipe: Steel water pipe, schedule 10 through 40

尺寸：2" - 8"  
 Size: 2" - 8"

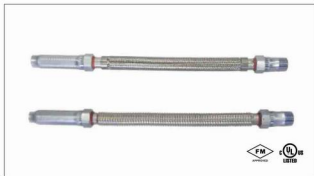
**喷淋软管**  
 Flexible Sprinkler Hose/Drop

用途：商业吊顶  
 Application: Commercial Suspended Ceilings

额定工作压力：14.9kg/cm<sup>2</sup> (200psi)  
 Rated Working Pressure: 14.9kg/cm<sup>2</sup> (200psi)

测试压力：56.2kg/cm<sup>2</sup> (800psi)  
 Test Pressure: 56.2kg/cm<sup>2</sup> (800psi)

最高环境温度：135°C (275°F)  
 Maximum Ambient Temperature: 135°C (275°F)

最小弯曲半径：175mm (7 in.)  
 Minimum Bending Radius: 175mm (7 in.)

进水口尺寸：1" NPT (可选择：BSPT / Rp)  
 Inlet Size: 1" NPT (BSPT and Rp is optional)

出水口尺寸：1/2" 和 3/4" NPT (可选择：BSPT / Rp)  
 Outlet Size: 1/2" and 3/4" NPT (BSPT and Rp is optional)

长度范围：700mm, 1000mm, 1200mm, 1500mm, 1800mm  
 Lengths: 700mm-1000mm-1200mm-1500mm-1800mm

抗震系统支撑部件  
Seismic Bracing System Parts



梨形吊架  
Swivel Ring Hanger SH01



尺寸范围: 1/2" 到 8"  
Size range: 1/2" up to 8"  
材质: 镀锌  
Material: carbon steel  
成品: 镀锌, 根据客户要求  
Finish: galvanized, other finish available upon request  
使用范围: 1. 建议用在悬空的非绝缘固定点的支撑。2. 根据NFPA最小螺杆尺寸标准生产  
Service: 1. Recommend for suspension of non-insulated stationary pipe  
www.zqfire.com. 2. Manufactured to use the min. rod size permitted by NFPA for fire sprinkler pipe line.

U型吊架  
Clevis Hanger



尺寸范围: 3/8", 1/2" 或 M10, M12  
Size range: 3/8" and 1/2" or M10 and M12  
材质: 球墨铸铁, 淬水硬丝和防松螺母  
Material: ductile iron, hardened steel cup point set screw and locknut.  
成品: 黑色或镀锌  
Finish: black or galvanized  
使用范围: 顶部或底部的金属横梁、槽、通道或角钢  
Service: structural attachment to top or bottom of metal beams, purflin, channel or angle iron.

梁夹  
Beam Clamp



尺寸范围: 3/8", 1/2" 或 M10, M12  
Size range: 3/8" and 1/2" or M10 and M12  
材质: 球墨铸铁, 淬水硬丝和防松螺母  
Material: ductile iron, hardened steel cup point set screw and locknut.  
成品: 黑色或镀锌  
Finish: black or galvanized  
使用范围: 顶部或底部的金属横梁、槽、通道或角钢  
Service: structural attachment to top or bottom of metal beams, purflin, channel or angle iron.

杯型吊架  
Cup Nut Pipe Loop



尺寸范围: 1" 到 8"  
Size range: 1" up to 8"  
材质: 碳钢  
Material: carbon steel  
成品: 镀锌  
Finish: galvanized  
使用范围: 自动喷水灭火系统。  
Service: automatic sprinkler system.  
配置: 提供法兰螺母、螺栓。  
Configuration: supplied with flange nut and cup nut.

抗震连接座A  
Seismic Connecting Seat A



表面处理电镀锌 (EG) 或热浸镀锌 (HDG)。  
Surface treatment: electro-galvanized (EG) or hot-dip galvanized (HDG).  
通用设计可装配到各种结构体, 包括混凝土、木质结构、工字梁及各自的连接座上。  
Universal design can be installed to a variety of structures, including concrete, wood structures, beams and a respective connector.  
符合NFPA-13抗震支撑要求。  
Meet NFPA-13 seismic support requirements.

抗震连接座B  
Seismic Connecting Seat B



表面处理电镀锌 (EG) 或热浸镀锌 (HDG)。  
Surface treatment: electro-galvanized (EG) or hot-dip galvanized (HDG).  
双头螺栓螺母无需使用扭力扳手, 直至螺栓头脱落, 再次抗震支撑的安装及检查。  
Double wing bolt without using a torque wrench until the bolt head off, simplifying installation and inspection of seismic support.  
符合NFPA-13抗震支撑要求。  
Meet NFPA-13 seismic support requirements.

可调试铰链A  
Adjustable Hinge A



表面处理电镀锌 (EG) 或热浸镀锌 (HDG)。  
Surface treatment: electro-galvanized (EG) or hot-dip galvanized (HDG).  
适用于纵向和侧向抗震支撑应用。  
Suitable for longitudinal and lateral seismic bracing applications.  
符合美国联邦技术规范WW-H-171 (类型B) 以及制造商协会 (MSS) sp-59sp-69 (类型B)。  
Comply with Federal Specification WW-H-171 (Type B) and Manufacturers Association (MSS) sp-59sp-69 (Type B).

可调试铰链B  
Adjustable Hinge B



表面处理电镀锌 (EG) 或热浸镀锌 (HDG)。  
Surface treatment: electro-galvanized (EG) or hot-dip galvanized (HDG).  
通过槽钢螺母与之进行连接, 将螺栓拧至既定扭矩。  
controlled by a channel nut of the screw bolts to the specified torque.  
符合美国联邦技术规范WW-H-171 (类型B) 以及制造商协会 (MSS) sp-59sp-69 (类型B)。  
Comply with Federal Specification WW-H-171 (Type B) and Manufacturers Association (MSS) sp-59sp-69 (Type B).

应用有限元分析软件设计产品，技术先进，质量可靠。

The products were designed by analysis software, with advanced technology and reliable quality.

### V型加劲装置

V-type Stiffening Device



表面处理: 电镀锌 (EG)  
Surface treatment: electro-galvanized (EG)

### C型槽钢41x41x2.5mm

C-type Channel 41x41x2.5mm



长度3米和6米  
Length: 3m and 6m  
表面处理: 电镀锌 (EG) 或热浸镀锌 (HDG)  
Surface treatment: electro-galvanized (EG) or hot-dip galvanized (HDG)

### 背孔C型槽钢41x41x2.5mm

Back Hole C-type Channels 41x41x2.5mm



长度3米和6米  
Length: 3m and 6m  
背孔 14x27mm, 每隔50mm  
Back hole 14x27mm, every 50mm  
表面处理: 电镀锌 (EG) 或热浸镀锌 (HDG)  
Surface treatment: electro-galvanized (EG) or hot-dip galvanized (HDG)

### 背孔CB型悬壁槽钢2 (41x41x2.5) mm

Back Hole CB-type Cantilever Channel 2 (41x41x2.5)mm



基本 165x50x8mm, 带1个竖向和横向背孔 14x27mm  
Basic 165x50x8mm, with a vertical and horizontal back hole 14x27mm  
可提供长度: 300mm-900mm  
Available length: 300mm - 900mm  
表面处理: 电镀锌 (EG) 或热浸镀锌 (HDG)  
Surface treatment: electro-galvanized (EG) or hot-dip galvanized (HDG)

### 六角连接器

Hexagonal Connector



表面处理: 电镀锌 (EG)  
Surface treatment: electro-galvanized (EG)

### 化学锚栓

Chemical Anchor



提供尺寸: M8-M12  
Provide Size: M8-M12  
配备六角螺母和垫圈  
Equipped with hex nut and washer  
表面处理: 电镀锌 (EG)  
Surface treatment: electro-galvanized (EG)

### 双头拧断螺栓

Hexagonal Connector



表面处理: 电镀锌 (EG)  
Surface treatment: electro-galvanized (EG)

### 槽钢螺母(带弹簧)

Chemical Anchor



表面处理: 电镀锌 (EG)  
Surface treatment: electro-galvanized (EG)

我们的沟槽式管件通过FM、UL认证，压力等级为300PSI，材质为球墨铸铁，表面处理为环氧树脂。  
Our grooved fittings were certified by FM and UL, The pressure rating is 300PSI, material is ductile iron, coating is epoxy resin.

45° 弯头  
45° Elbow



90° 弯头  
90° Elbow



大小头  
Concentric Reducer



正三通  
Equal Tee



法兰短管  
Flange Adaptor



柔性接头  
Flexible Coupling



机械四通  
Mechanical Cross



机械三通  
Mechanical Tee



变径柔性接头  
Reducing Coupling



异径三通  
Reducing Tee



刚性接头  
Rigid Coupling



Uxz型机械三通  
U-Bolted Mechanical Tee



接头  
Coupling



四通  
Cross



四通  
Cross



弯头  
Elbow





我们可以用碳钢或不锈钢制作材料生产不同尺寸的消防装备箱，可以做成墙壁式、地面式和嵌入式。  
We can produce different size fire equipment cabinet by carbon steel or stainless steel, it can be wall mounted type, stand type and recessed type.

### 消火栓箱 Riser Cabinet



落地阀和水泵结合器箱。  
Landing valve and breaching inlet boxes.  
该箱尺寸小，以适应一个落地阀或者一个水泵结合器入口。  
The Cabinet is small to suit for one landing valve or one breaching inlet.  
通常安装在墙壁上。玻璃门是6mm厚的有机玻璃。  
Normally mounted on the wall. Glazing in the door is of wired glass 6mm thick.  
材质为碳钢或不锈钢。  
Material is carbon steel or S.S.  
以RAL3000红色粉末涂层完成。  
Completed with powder coated RAL 3000 Red.

### 美式消防水带箱 America Type Fire Hose Cabinet

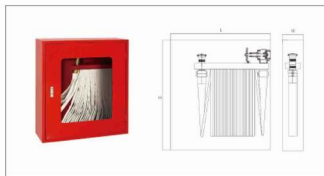

尺寸: 710\*710\*300mm (可根据要求定制)  
Size: 710\*710\*300mm (upon to the request)  
厚度: 1.2mm或其他; 成品: 消防红, 可有或无玻璃。  
Thickness: 1.2mm or others. Finished: Fire red color and can be with or without glass.  
一条带喷嘴和落地阀(软管角阀)消防水带。喷嘴可以是英式、美式或德式。为了与落地阀连接, 如果落地阀是美式的, 但水带接口是英式, 这时您还需要一个转换器。  
One fire hose with nozzle and landing valves (angle hose valve). Nozzle can be BS type, American type or German type. In order to connect with the landing valve, if the landing valve is BS type, but the hose is American type, at this time you will need an adaptor.  
如果采用美式, 柜门尺寸使用1-1/2" 或2-1/2"  
If use American type, valves size use 1-1/2" or 2-1/2"  
如果采用英式, 柜门尺寸使用2" 或2-1/2"  
If use BS type, valves size use 2" or 2-1/2"  
接口可以在2-1/2" 的尺寸之间进行转换。  
The adaptor can convert between the 2-1/2" sizes.

### 泡沫水带箱 Foam Fire Hose Cabinet



尺寸: 1110\*700\*300mm (可根据要求定制)  
Size: 1110\*700\*300mm (Upon to the request)  
泡沫比例混合器: 1-6%  
Foam inductor: 1-6%  
泡沫液容积: 40L (可根据要求定制)  
Foam Container: 40L (Upon to the request)  
工作压力: 10-12bar  
working pressure: 10 - 12 bar  
配件: 泡沫液位计  
Accessories: Foam level gauge  
旋转式支架水带: 45mm\*40mm X 30M  
Swing arm fire hose: 45mm\*40mm X 30M  
水带接口类型: 1.5NH, DSP40, UNE45  
Connection: 1.5NH, DSP40, UNE45  
泡沫枪接口: G 1.5  
Inlet: G 1.5  
泡沫枪出口口径: 9mm/12mm  
Outlet: 9mm/12mm

传统的火灾报警面板  
Conventional Fire Alarm Panel



适用于2/4/8/16检测区域的常规面板系列。  
Conventional panel series available for 2/4/8/16 detection zones.

每个区域包括探测器和手动报警点多达25台设备。  
Up to 25 devices for each zone including detector and manual call point.

LED指示适用于检测区，发声电路和火灾报警器输出短路或开路。  
LED indications available for short or open circuit of detection zone, sounder circuit and fire alarm outputs.

手动设定白天和夜晚模式。  
Manual settable between DAY and NIGHT mode.

可选信号可用于火灾和故障输出的扩展需求输出板。  
Optional signal output board available for extension needs of fire and fault outputs.

预留中继器面板接口为多个区域的火灾报警指示。  
Reserved repeater panel interface for fire alarm indication of multiple zones.

再线制，以减少安装本线和安装支路。  
Two wire system to reduce installation cabling and installer friendly.

LPCB认证符合EN54-2和EN54-4标准。  
LPCB approval in compliance with EN54-2 and EN54-4.

传统的光学烟雾探测器  
Conventional Optical Smoke Detector



探测器能准确地探测到发生在24小时内的慢性火灾。  
The detector can accurately detect the chronic fire happened in 24 hours.

独特的室内设计，用于防止灰尘、昆虫和其他外部干扰。  
Unique chamber design for protection against dust, insects and other external interferences.

不用单个螺丝的优秀结构设计。  
Talented designed of structure without a single screw.

LPCB认可符合EN54-7。  
LPCB approval on compliance with EN54-7.

传统的双热探测器  
Conventional Dual Heat Detector



使用灵敏度高的热传感器，增强温度变化的快速反应。

Use thermal sensor with high sensitivity, enhance quick response to variation of temperature.

不用一个单螺丝的优秀结构设计。  
Talented design of structure without a single screw.

LPCB认证符合EN54-5。  
LPCB approval on compliance with EN54-5.

传统的手动报警按钮  
Conventional Manual Call Point

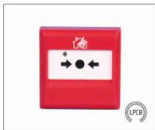

无玻璃破碎激活。  
No glass breaking activation.

特殊复位。  
Resettable by special key.

LED指示灯提供设备的状态。  
LED indicator provides the status of device.

LPCB认证符合EN54-11。  
LPCB approval in compliance with EN54-11.

传统的声光报警器  
Conventional Sounder Strobe



警铃声和闪光结合在一起。  
Alert sound and flash combined in one unit.

可选择10种不同的音调。  
A selection of 10 different tones.

使用超亮LED作为光源指示来源。  
Using ultra bright LEDs as source for light indication.

LPCB认可符合EN54-3。  
LPCB approval in compliance with EN54-3.

传统的警铃  
Conventional Alarm Bell



低功耗高性能。  
Maximum performance with low power consumption.

适用于壁挂式安装或任何标准的安装盒。  
Suitable for wall-mount installation or any standard mounting box.

不可恢复式缆式感温火灾探测器  
Digital Type Linear Heat Detector



特殊盒  
Linear Detector Interface



具有火灾和误报指示。  
With heat fire and fault indication,  
火灾和误报输出。  
Fire and fault relay output available.  
金属闪光  
Metal flash  
工作电压:24VDC  
Operating Voltage:24VDC  
温度:-55℃~60℃  
Temperature:-55℃~60℃  
防护等级:IP66  
IP Rating IP66

终端  
End of Line Unit



功能是非平衡信号状态。  
The function is balancing the signal status.  
适用于不可恢复感温电缆的探测、报警、模拟误报。  
For Digital linear heat cable monitoring and alarm/fault simulating.  
工作电压:无需供电  
Operating Voltage:no need power.  
温度:-55℃~60℃  
Temperature:-55℃~60℃  
防护等级:IP66  
IP Rating IP66

感温电缆具有连续的灵敏度,沿感温电缆任意一段,任意一点均可以探测由温度过热引发的火灾。  
The detector has continuous sensitivity,any point or any length of the cable the temperature rise will initiate the alarm.

感温电缆灵敏度不受使用长度和周围环境温度的影响。

The sensitivity of linear heat detector will not have influenced by the environment temperature changing and the length of detection cable using.

工作电压:DC 24V  
Operating voltage:DC 24V.

报警温度:68℃,88℃,105℃,138℃,180℃  
Alarm temperature:68℃,88℃,105℃,138℃,180℃.

认证:FM  
Approval:FM.

系统连接图

System Connection Diagram

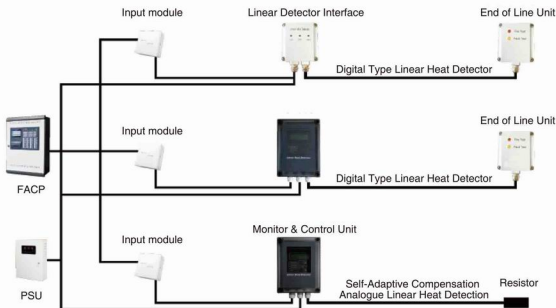

### 自适应补偿式可恢复式缆式感温探测器

#### Self-Adaptive Compensation Analogue Linear Heat Detection



绝缘: 2芯和3芯线: 高分子聚合物; 1芯和4芯 线 ( 或其它线芯 ); 特殊金属。  
Insulation: Cores 2 and 3: Specialty Doped Polymer; Cores 1 and 4: PVC; Other Cores (if have): Special Material.

外护套颜色: 1芯: 红色; 2芯: 白色; 3芯: 蓝色; 4芯: 黄色; 5或6芯: 为黄色和绿色。  
Cable Color: 1=Red; 2=White; 3=Blue; 4=Yellow; 5 or 6 (if have)= Yellow or Green.

使用寿命: 100° C以内30年寿命。  
Service Life: 30 year service life up to 100°C.

抗电压强度: 线芯和外护套之间的抗压强度为10KV。  
Voltage Proof: 10 kV between outer sheath and a conductor.

最大铺设距离: 9米。  
Maximum Distance for Laying: 9 m (Refer to UL521 and FM3210).

认证: UL, CE。  
Approval: UL and CE.

类型 Type	外径 External Diameter	最小抗张力 Minimum Tensile Strength	工作温度 Operation Temperature
高温PVC High Temperature PVC	3.2mm	100N	-20°C - 100°C
聚四氟乙烯 Polytetrafluoroethylene			-40°C - 160°C
铜质编织外护套, 防爆防电磁辐射。 Bronze Braid for Explosion and EM-Proof.			

类型 Type	温度设置 Temperature Definition	工作温度 Operation Temperature	电源 Power Supply
定温型 Fixed Temperature	68-140°C	-20°C - +70°C	电压 Voltage 24 Vdc ± 20%
差温型 Rate-of-Rise of Temperature	8.3-30°C/min		
定差温型 Fixed and Rate-of-Rise of Temperature	68-140°C 8.3-30°C/min		



**消防炮**  
Fire Monitor



额定工作压力:1.0Mpa  
Rated working pressure: 1.0Mpa

流量:30-80L/S  
Flow: 30-80L/S

射程:≥80m (仰角30°)  
Range: ≥80m (elevation 30°)

喷雾角度:120°  
Spray angle: 120°

水平旋转角度:≥270° (可调)  
Horizontal rotation angle: ≥270°(Adjustable)

俯仰角度: -30° ~+70° 或 -70° ~+70° (可调)  
Pitch angle: -30° ~+70° or -70° ~+70° (Adjustable)

回转控制电机类型:1) 380V防爆型Exd II BT4; 2) DC24V防护型IP65; 3) DC24V防爆型  
Swing control/electronic control types: 1) 380V explosion-proof ExdII BT4; 2) DC24V protection type IP65; 3) DC24V explosion-proof

开花/直流控制类型:1)380V防爆型Exd II BT4; 2) DC24V防护型IP65  
Flowering / DC control types: 1) 380V explosion-proof ExdII BT4; 2) DC24V Protection type IP65

炮体结构: 铝合金铸件  
Monitor structure: aluminum alloy castings

炮嘴材质: 1) 铝合金; 2) 黄铜  
Monitor mouth material: 1) aluminum alloy; 2) brass.

**移动式消防炮**  
Portable Monitor

额定工作压力: 1.0Mpa;  
Rated working pressure: 1.0Mpa;

流量: 30-80L/S (自动调节);  
Flow: 30-80L/S (Automatic pressure regulating);

射程: ≥75m @ 80L/S;  
Range: ≥75m @ 80L/S;

水平旋转角度360° 上下俯仰角度: 0-90° ;  
Horizontal rotation angle: 360°, Up and down pitch angle: 0-90°;

进水管: 2 × 65mm;  
Water inlet: 2x65mm;

可拆卸式结构, 选配定制法兰底座可组装成固定炮使用;  
Detachable structure, which can be matched with the custom flange seat, then can be assembled into a fixed monitor;

独特的超长整流器, 确保射程, 且能降低风速对射程的及射流的影响;  
Unique super long rectifier, which can ensure the range, and can reduce the impact of wind speed on the range and jet flow;

不锈钢可折叠支架;

Stainless steel folding support;

自动泄水功能, 当炮体内压力低于0.2Mpa时, 自动排空炮体内残留水;  
Automatic discharge function, when the pressure inside the monitor less than 0.2Mpa, it can automatically empty the residual water in the monitor body;



我们提供各类消防安全装备，保障生命和财产安全。  
We provide all kinds of fire fighting equipment, to ensure the safety of life and property.

消防毯  
Fire Blanket



防火毯与干粉灭火器或湿化学灭火器配  
置使用能增加防火安全  
Fire blankets can be used along with dry powder  
fire extinguishers or wet chemical extinguishers  
for increased fire safety.

独立感烟探测器  
Stand Alone Smoke Detector



易安装：可直接安装到正确位置无需任  
何接线  
Easy to install: install directly to proper location  
without any wiring.  
易维护：电池至少一年可正常运行  
Easy to maintain: minimum one year battery life  
under normal operation.  
易测试：LED警报指示器是测试按钮，  
按压2秒后会听到警报声由此来确认是否  
处于正常工作状态  
Easy to test: the LED alarm indicator doubles as  
a test button- just press it for 2 seconds and hear  
the alarm sound to confirm that it is working in  
normal condition.

消防服  
Fireman Suit



外层: NOMEKIIIA 热封: 芳纶纤维  
Outer shell: NOMEKIIIA Thermal Iring: aramid felt  
隔热层: 芳纶水刺基材和PTFE薄膜  
Moorsure barrier: aramid spunlouse substrate with  
PTFE membrane  
衬垫层: 芳纶、粘胶纤维混合物  
Comfortable layer: aramid/cottonsew mixen fabric  
颜色: 黑色、深蓝色、红色、橙色、黄色  
Color: Black, Navy blue, Red, Orange, Yellow  
标准: EN 469:2005+A1:2006, NFPA 1971-2007,  
NFPA 1971-2009, NFPA 1975:2009

救援头盔  
Rescue Helmet



轻质芳纶玻璃纤维增强型复合材料外壳。  
Light weight Kevlar/fiberglass reinforced  
composite shell.  
抗紫外线喷漆。  
UV resistant hi-gloss paint finish.  
可拆卸的皮革头带。  
Removable leather headband.  
Headband with removable leather for cleaning  
and replacement.  
内部可伸缩护目镜。  
Internally retractable eye protector.  
认证: EN443 EN12492.  
Certification: EN443 EN12492.

手动曲柄警报器  
Hand Crank Siren



类型: 便携式  
Style: Portable  
声压级(A): 1M 110 ± 2  
Sound level dB(A): 1M 110±2  
输出频率(HZ): 550 ± 20  
Output Frequency(HZ): 550±20  
传输距离: 1000m  
Transmission Distance: 1000m  
材料: 铝合金  
Material: Aluminum Alloy  
净重: 1.2KG  
Net weight: 1.2KG

呼吸器  
Breathing Apparatus



特点: 快速组合, 可以同时两人或三人  
使用。  
Features: Quick combination, simultaneously  
available by two or three persons.

救援工具  
Rescue Tool



双压机动泵  
Double Output Motor Pump



液压剪断器  
Hydraulic Cutter



液压扩张器  
Hydraulic Spreader



液压顶器  
Hydraulic Jack Set

## 上海铁人消防成套设备有限公司

Shanghai Iron Man Fire Fighting Equipment Co.,Ltd.

地址：上海市浦东新区秀沿路100号7楼716室 邮编：201315  
电话：+86-21-68062016/7 传真：+86-21-68062016/7-307  
网址：[www.firefightingtool.com](http://www.firefightingtool.com)  
邮箱：[info@ironman-safety.com](mailto:info@ironman-safety.com)  
Add: Room 716, 7F, No.100, Xiuyan Road, Shanghai 201315, China  
Tel: +86-21-68062016/7 Fax: +86-21-68062016/7-307  
E-mail: [info@ironman-safety.com](mailto:info@ironman-safety.com)  
Website: [www.firefightingtool.com](http://www.firefightingtool.com)

